

Signify[®]

RETRO TURNTABLE BRIEFCASE



Model Number: EA2147



INSTRUCTION MANUAL

Welcome

Congratulations on choosing to buy a Signify® product.

All products brought to you by Signify® are manufactured to the highest standards of performance and safety, and, as part of our philosophy of customer service and satisfaction, are backed by our comprehensive 1 Year Warranty and customer technical support line.

This comprehensive instruction manual will provide you with a detailed guide on how to operate your product and will also assist you in troubleshooting any problems that you may encounter.

If you have any queries regarding the use of this product, please feel free to phone our technical support line for some friendly advice. If you are experiencing difficulties or believe that the product may have a technical fault, we will assist you in rectifying the issue. We can generally solve most problems simply and quickly over the phone, so please always phone us first!

We are sure that you will enjoy using this product and you can expect to gain years of service from this product when it is used and maintained in the correct manner.

Contents

Welcome	02
Warranty Details	04
General Information and Safety Instructions	05
Product Overview	08
Getting Started	11
Before First Use	11
Removing the Turntable Protective Packaging	11
Power Input	11
Playback Modes	11
Playback Controls	11
Instructions	12
Handling Vinyl Records	12
Playing Vinyl Records	12
Playing a USB Drive/Micro SD Card	13
Using the Auxiliary Input	14
Using the Bluetooth® Connection	14
Using the FM Radio	15
Using the Headphone Output	16
Using the RCA Audio Output	16
Recording from the Turntable to USB Drive / Micro SD Card	17
Replacing the Stylus	18
Frequently Asked Questions	20
Repair and Refurbished Goods or Parts Notice	21
Other Useful Information	22
Cleaning and Maintenance	22
Storage	22
Responsible Disposal	23
Specification Table	23



Signify[®]

Retro Turntable Briefcase

Warranty Details

REGISTER YOUR PURCHASE AT www.aldi.com.au/en/about-aldi/product-registration/
TO KEEP UP-TO-DATE WITH IMPORTANT PRODUCT INFORMATION

The product is guaranteed to be free from defects in workmanship and parts for a period of 12 months from the date of purchase. Defects that occur within this warranty period, under normal use and care, will be repaired, replaced or refunded at our discretion. The benefits conferred by this warranty are in addition to all rights and remedies in respect of the product that the consumer has under the Competition and Consumer Act 2010 and similar state and territory laws.

Our goods come with guarantees that cannot be excluded under the Australian Consumer Law. You are entitled to a replacement or refund for a major failure and for compensation for any other reasonably foreseeable loss or damage. You are also entitled to have the goods repaired or replaced if the goods fail to be of acceptable quality and the failure does not amount to a major failure.

AFTER SALES SUPPORT

  1300 777 137

 service@unclebills.com.au

MODEL: EA2147 PRODUCT CODE: 718210 12/2024



General Information and Safety Instructions

RETAIN FOR FUTURE USE

Read this manual thoroughly before first use, even if you are familiar with this type of product. The safety precautions enclosed herein reduce the risk of fire, electric shock and injury when correctly adhered to. Please keep this instruction manual in a safe place along with your purchase receipt, warranty card and carton for future reference. If applicable, pass these instructions and packaging on to the next owner of the product. Always follow basic safety precautions and accident prevention measures when using an electrical product.

1. Read all instructions before using the Turntable Briefcase.
2. Never allow children to play with electrical equipment.
3. Do not use the Turntable Briefcase for anything other than its intended use.
4. Before turning on, ensure the electrical voltage and frequency of the circuit corresponds to those indicated on the rating label of the power adaptor.
5. Do not allow the Turntable Briefcase, its power adaptor, cord or plug to come into contact with water or any other liquid. Do not expose the Turntable Briefcase to spills, drips or splashes from objects filled with liquids, such as vases.
6. The Turntable Briefcase is not intended to be operated by means of an external timer or any type of separate remote control system.
7. The use of attachments not recommended or sold by the manufacturer is dangerous and may cause fire, electric shock or injury.
8. This Turntable Briefcase is intended to be used indoors, for household use only. Do not use the Turntable Briefcase outdoors.
9. Keep the Turntable Briefcase, its power adaptor, cord and plug out of direct sunlight.
10. Do not use an extension cord with this Turntable Briefcase unless completely necessary. If an extension cord is used, please ensure that it has a rating equal or exceeding the rating of the power adaptor.
11. Do not pull or carry by the power cord, use the cord as a handle, close a door on the cord, or pull the cord around sharp edges or corners. Keep the cord away from heated surfaces.
12. Do not bend or damage the power cord.
13. Always unplug the Turntable Briefcase when not in use. To disconnect from the power supply, first ensure the power switch is turned off, then grip the plug and pull from the power socket. Never pull by the cord. The power plug must be removed from the power socket before cleaning, servicing, or maintenance.
14. Unplug the Turntable Briefcase in cases of electrical storms to protect against the possibility of power surges damaging the Turntable.
15. Never force the plug into an outlet.

General Information and Safety

Instructions (cont.)

16. Ensure that power sockets are not overloaded by operating several electrical products that exceed the power supply of the socket. Review the rating label of each electrical product being operated to ensure that they do not exceed the capacity of the power socket. Always turn off and unplug any electrical product that is not being used.
17. Never operate the Turntable Briefcase with wet hands, submerge under water or spill liquids into the unit.
18. Always turn the Turntable Briefcase off and disconnect from the power source before cleaning. Never use liquid cleaners, use a soft dry (or slightly damp) cloth to wipe over.
19. Do not place the Turntable Briefcase near a hot burner (gas or electric), heat sources or open flames.
20. Improper installation may result in the risk of fire, electric shock and/or injury to persons.
21. If the power adaptor or its cord or plug is damaged, do not use the Turntable Briefcase. Please contact the After Sales Support Line for assistance.
22. Always ensure that the power adaptor and cord are placed in a safe location to ensure that they cannot be stepped on or cannot pose as a tripping hazard. Do not place any items on or against the power adaptor and cord.
23. The manufacturer and retailer are not responsible for any eventual damages caused by improper or faulty use.
24. The Turntable Briefcase and its power adaptor have no user serviceable parts contained within (with the exception of the stylus). Do not attempt to repair, disassemble or modify the Turntable Briefcase or its power adaptor.

NOTE: See page 18 for further details on how to replace the stylus.

25. This Turntable Briefcase is not intended for use by persons (including children) with reduced physical, sensory or mental capabilities or lack of experience and knowledge, unless they have been given supervision or instruction concerning use of the Turntable Briefcase by a person responsible for their safety. Children should be supervised to ensure they do not play with the Turntable Briefcase.
26. Ensure that all packaging and plastic bags that were included in the Turntable Briefcase gift box are kept out of reach from children to avoid potential danger of suffocation.
27. Do not use the Turntable Briefcase on an unstable surface.
28. The Turntable Briefcase must ONLY be powered by the power adaptor that is supplied with the product. Do not use any other power adaptor. If you experience difficulties with the power adaptor supplied, please contact the After Sales Support Line for assistance.
29. Be extremely careful when unpacking or relocating the Turntable Briefcase and its power adaptor. Ensure that the Turntable Briefcase and power adaptor are not dropped, bumped or have excessive force applied to it. Impacts such as these can damage the product and its internal components.

General Information and Safety Instructions (cont.)

30. We recommend that, where possible, to avoid moving the unit unnecessarily once placed.
31. For the protection of the Turntable Briefcase, we recommend that it is placed on a protected surface to prevent any damage.
32. If the Turntable Briefcase has been exposed to strong fluctuations in temperature (for example, after transport), do not switch it on immediately. Moisture and condensation could damage the equipment. Do not switch on the equipment until it has reached room temperature.
33. The Turntable Briefcase should always be repacked in its original packaging whenever transporting to prevent any possible damage to the device.
34. Where the mains plug or an appliance coupler is used as the disconnect device, the disconnect device shall remain readily operable.

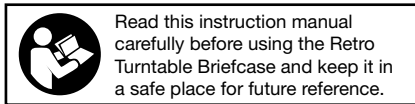

Product Overview

Front View

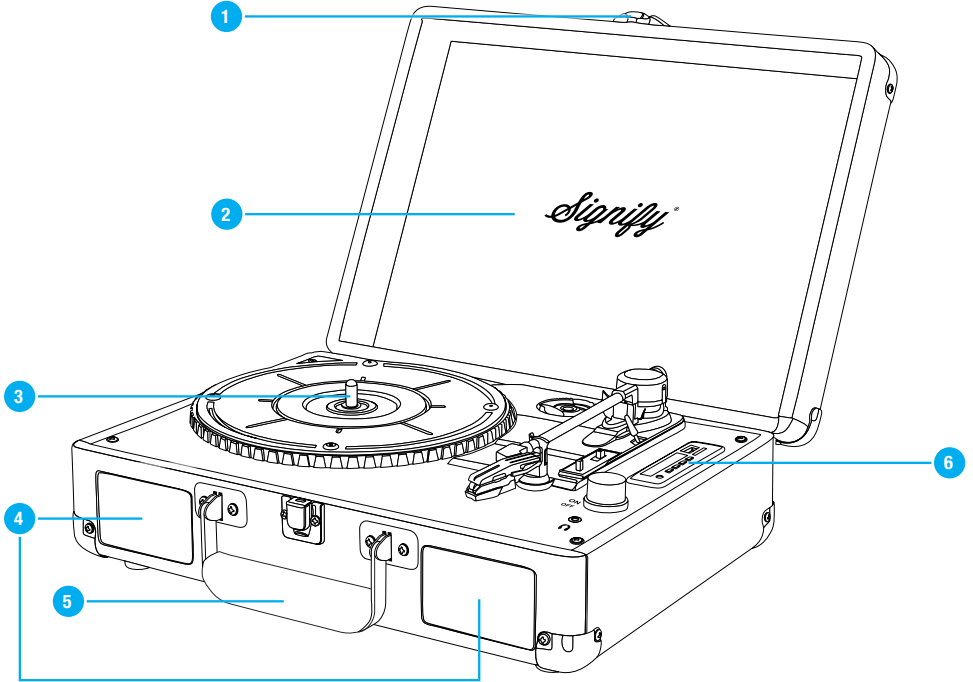

1. Lock Latch
2. Turntable Briefcase Lid
3. Turntable Platter
4. Speakers
5. Handle
6. LED Control Panel (for USB drive / Micro SD card playback)

Product Overview (cont.)

Turntable

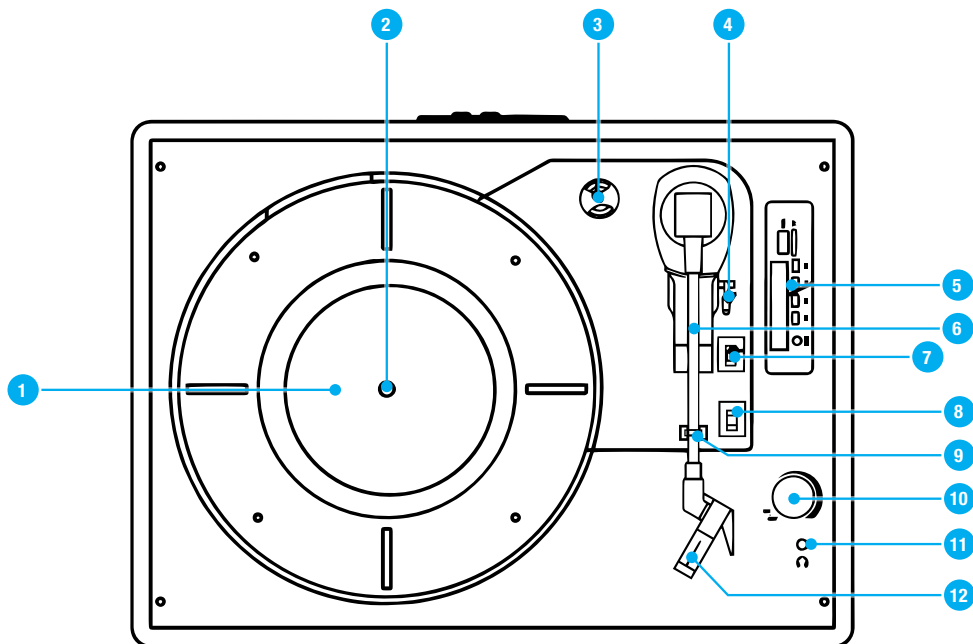

- | | |
|---|--|
| 1. Turntable Platter | 7. Speed Selection Switch (33, 45, 78 RPM) |
| 2. Spindle | 8. Auto Stop ON/OFF Switch |
| 3. 45 RPM Adaptor | 9. Tone Arm Lock |
| 4. Cue Lever | 10. Power/Volume Dial |
| 5. LED Control Panel (for USB drive/Micro SD card playback) | 11. Headphone Output |
| 6. Tone Arm | 12. Stylus |

Product Overview (cont.)

Front and Rear Control Panels

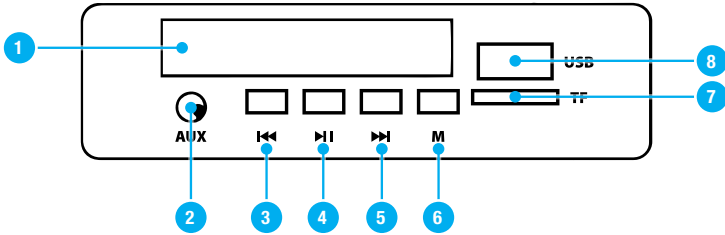

- | | |
|---------------------------|----------------------|
| 1. LED Display Screen | 7. Micro SD Input |
| 2. AUX Input | 8. USB Input |
| 3. ⏮ Button | 9. FM Antenna |
| 4. ⏭ Button | 10. RCA Audio Output |
| 5. ▶▶ Button | 11. DC Power Input |
| 6. M (Mode) Button | |

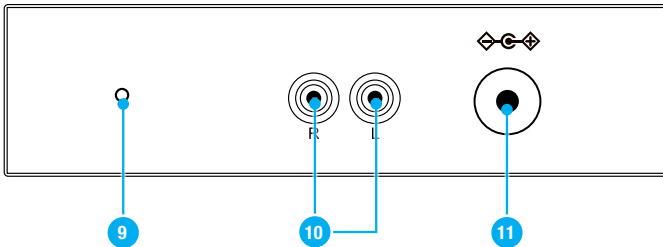

Included (not pictured):
1x Power Adaptor, 1x Instruction Manual and 1x Warranty Certificate.

Getting Started

Before First Use

Prior to using your Turntable Briefcase, please read all safety and operating instructions thoroughly. Please ensure you follow the steps below before using this device. We recommend you keep the original packaging for storing your Turntable Briefcase when not in use.

Removing the Turntable Protective Packaging

1. Unlock the Lock Latch on the front of the Turntable Briefcase, and lift the Turntable Briefcase Lid to reveal the Turntable Platter.
2. Peel off the protective tape and remove the twist tie from the Tone Arm.
3. Remove the protective cover from the stylus.

Power Input

Once all packaging has been removed, insert the Power Adaptor into a power socket and connect the other end to the DC Power Input (rear panel of the unit) and switch the power socket on.

Playback Modes

There are six playback options available for use in the Turntable Briefcase being; Turntable, USB, Micro SD, FM Radio, Bluetooth® and AUX. Each playback mode is explained in the following pages allowing you to enjoy listening to your music from a wide variety of formats and sources.

The default playback mode is the Turntable mode and is shown on the LED Display Screen as -PHO. Press the **M** button to scroll through the available playback modes, noting that some modes will not be selectable unless external media sources are connected (USB, Micro SD and AUX).

When an external source is connected such as a USB, Micro SD card or AUX cable the LED Control Panel will automatically select the relevant playback mode. If the USB drive or Micro SD card have music stored in folders, these will not be recognised by the Turntable Briefcase. The music will play in the order it is stored on the USB drive or Micro SD card.

Playback Controls

The below controls only apply to music playback through the USB drive and Micro SD Card formats.

Button	Function
⏮	Skip to previous track / rewind through track in progress
⏸	Play / Pause or delete track
⏭	Skip to next track / fast forward through track in progress
M	Scroll through the available playback modes

WARNING: During playback of tracks on USB drive or Micro SD, a press and hold of the Play/Pause button will delete the track in progress.

Instructions

Handling Vinyl Records

NOTE: Only handle vinyl records with clean hands and hold them by the edge or the label. Do not touch the record grooves.

- Keep your vinyl records in protective sleeves when not in use to avoid dust and scratches.
- Store vinyl records upright. Records stored horizontally may bend and warp.
- Avoid placing vinyl records in direct sunlight, close to any heat source (radiator, stoves etc.) or in a location that may be subject to vibration, excessive dust, heat, cold or moisture.
- To clean a vinyl record, gently wipe the surface in a circular motion using a soft anti-static cloth.

Playing Vinyl Records

To play a vinyl record, follow the steps below.

1. Turn the **Power/Volume Dial** clockwise until you hear a 'click' sound. The LED Display Screen will show the welcome message HI briefly, then show -PHO indicating that the Turntable mode is active. This is the default setting for the Turntable Briefcase.

IMPORTANT: Before playing a vinyl record, turn down the volume of the Turntable Briefcase to avoid possible loud crackling noises. The crackling noises made by the stylus coming into contact with the vinyl record could damage the unit. Wait until the stylus is completely placed on the vinyl record, and then turn up the volume.

2. Set the **Auto Stop Switch** to the ON position. The unit will now be set to automatically stop after the completion of play of the vinyl record. If the **Auto Stop Switch** is set to the OFF position, the unit will not stop automatically when the vinyl record is completed and the Turntable Platter will constantly spin.

NOTE: While the Turntable Platter is spinning no other playback mode can be activated.

3. Choose the desired playing speed using the **Speed Selection Switch** (No. 7 on the Turntable parts list). Select between 33, 45 and 78 RPM.

NOTE: When playing a 45 RPM record, use the included 45 RPM adaptor on the record spindle.

4. Carefully place the vinyl record on the Turntable Platter.
5. Unlock the Tone Arm Lock by moving it up and away from the Tone Arm itself.
6. Raise the Tone Arm using the Cue Lever, or carefully with your hand.
7. Place the Tone Arm vertically over the first track or over the outer edge of the vinyl record. The Turntable Platter will start spinning if the **Auto Stop Switch** is set to the ON position.

Instructions (cont.)

- Lower the Stylus onto the vinyl record using the Cue Lever.
- Turn the **Power/Volume Dial** clockwise to increase the volume, or turn the **Power/Volume Dial** anticlockwise to decrease the volume.
- To stop playing, lift the Tone Arm using the Cue Lever or your hand and place it back into the Tone Arm rest. Secure the Tone Arm once more by engaging the Tone Arm Lock. Cover the Stylus with the protective cover if needed.

Playing a USB Drive/Micro SD Card

You can play digital music from a USB drive or Micro SD card using the Turntable Briefcase.

- Turn the **Power/Volume Dial** clockwise until you hear a 'click' sound. The LED Display Screen will show the welcome message HI briefly, then show -PHO indicating that the Turntable mode is active. This is the default setting for the Turntable Briefcase.

NOTE: The Tone Arm must be in the Tone Arm rest or the Turntable Briefcase will automatically select the Turntable playback mode. Ensure that the Auto Stop Switch is in the ON Position.

IMPORTANT: Before playing music/media from a USB drive or Micro SD card, turn down the volume of the Turntable Briefcase to avoid a possible loud output from the speakers. Wait until the music/media is playing and then turn up the volume.

IMPORTANT: Before inserting a USB drive or Micro SD card into the unit, ensure that the Turntable Platter is not spinning. While the Turntable Platter is spinning no other playback modes can be selected.

- Insert a USB drive or Micro SD Card into USB input or Micro SD input. The LED Display Screen will briefly show the -LOD message while the music loads.

NOTE: When inserting a Micro SD card into the Micro SD input, the top of the Micro SD card should be facing away from the LED Display Screen. The Micro SD card can only be inserted in the correct direction. Never force the Micro SD card into the Micro SD input.

- Any music loaded on the storage device will then begin to play automatically.
- Use the Playback Controls to pause or skip forwards and backwards through the stored tracks. The Playback Controls can be seen on page 11 of the manual.
- Once you have finished playback from a USB drive or Micro SD card press the **M** button to scroll through the other available playback modes.

NOTE: Ensure that before the USB drive or Micro SD card is removed from the LED Control Panel that playback has been paused by pressing the Play/Pause button once.

Instructions (cont.)

Using the Auxiliary Input

The Turntable Briefcase features a 3.5mm AUX input which allows audio devices a 3.5mm output such as CD players, Smartphones, Tablets or Computers to be played through the units inbuilt speakers. To use the AUX input, follow the steps below.

1. Turn the **Power/Volume Dial** clockwise until you hear a 'click' sound. The LED Display Screen will show the welcome message HI briefly, then show -PHO indicating that the Turntable mode is active. This is the default setting for the Turntable Briefcase.

NOTE: The Tone Arm must be in the Tone Arm rest or the Turntable Briefcase will automatically select the Turntable playback mode.

IMPORTANT: Before playing music/media from the desired device, turn down the volume of the Turntable Briefcase to avoid a possible loud output from the speakers. Wait until the music/media is playing and then turn up the volume.

2. Connect one end of the AUX cable (not included) into the AUX input on the LED Control Panel of the Turntable Briefcase.
3. Connect the other end of the AUX cable into the desired media device.
4. Use the media device (not the Turntable Briefcase) to control playback.

NOTE: The volume can be controlled on both the connected media device and the Turntable Briefcase itself.

Using the Bluetooth® Connection

The Turntable Briefcase features a wireless Bluetooth® connection enabling music to be streamed directly from compatible devices such as Smartphones, Tablets or Computers. Before using the Bluetooth® connection you must first pair your chosen device. Please follow the steps below to pair and use the Bluetooth® connection.

Pairing your Bluetooth® enabled device

1. Turn the **Power/Volume Dial** clockwise until you hear a 'click' sound. The LED Display Screen will show the welcome message HI briefly, then show -PHO indicating that the Turntable mode is active. This is the default setting for the Turntable Briefcase.

NOTE: The Tone Arm must be in the Tone Arm rest or the Turntable Briefcase will automatically select the Turntable playback mode. Ensure that the Auto Stop Switch is in the ON Position.

2. Press the **M** button to scroll through the available playback modes and select Bluetooth® playback mode. The LED Display Screen will show the message bt that will be constantly flashing.
3. Switch on the Bluetooth® functionality on your device and scan for available connections. The Turntable Briefcase will be shown in the available connections as SIGTURN.

Instructions (cont.)

4. Select SIGTURN from the list. Depending on your device you may be prompted to enter a pass code. If requested enter the code '0000'.
5. When the letters bt stop flashing on the LED Display Screen, your device has now been paired and you can begin using your connected device.

NOTE: If no device is paired the bt message shown on the LED Display Screen will constantly flash. When a previously paired device is found it will automatically connect to the Turntable Briefcase.

NOTE: The volume can be controlled on both the connected media device and the Turntable Briefcase itself.

NOTE: Use playback controls on your connected device to navigate through your music selections.

Using your previously paired Bluetooth® enabled device.

1. Turn the **Power/Volume Dial** clockwise until you hear a 'click' sound. The LED Display Screen will show the welcome message HI briefly, then show -PHO indicating that the Turntable mode is active. This is the default setting for the Turntable Briefcase.

NOTE: The Tone Arm must be in the Tone Arm rest or the Turntable Briefcase will automatically select the Turntable playback mode. Ensure that the Auto Stop Switch is in the ON Position.

2. Press the **M** button to scroll through the available playback modes and select Bluetooth® playback mode. The LED Display Screen will show bt.
3. Allow a few seconds for the Turntable Briefcase to automatically connect to your previously paired Bluetooth® device.
4. Once the connection is made the bt message will stop flashing on the LED Display Screen and you can begin using your connected device.

Using the FM Radio

1. Turn the **Power/Volume Dial** clockwise until you hear a 'click' sound. The LED Display Screen will show the welcome message HI briefly, then show -PHO indicating that the Turntable mode is active. This is the default setting for the Turntable Briefcase.

NOTE: The Tone Arm must be in the Tone Arm rest or the Turntable Briefcase will automatically select the Turntable playback mode. Ensure that the Auto Stop Switch is in the ON Position.

IMPORTANT: Before playing music from the FM Radio, turn down the volume of the Turntable Briefcase to avoid a possible loud output from the speakers. Wait until the music is playing, and then turn up the volume.

Instructions (cont.)

2. Press the **M** button to scroll through the available playback options and select FM Radio playback mode. The LED Display Screen will show the FM icon lit and the current frequency the Turntable Briefcase is tuned to in MHz.
3. Fully uncoil the FM antenna found on the rear panel. Adjust the position of the antenna if required to acquire a clear signal.
4. Press and hold the **HI** button for about two seconds for the Turntable Briefcase to automatically search and store FM radio stations into the Pre-Sets memory. The Stations will be saved as P01, P02, and so on until the scanning is complete and all available stations have been saved into the memory.
5. To scroll through the saved Pre-Set stations use the **◀◀** or **▶▶** buttons to move forwards to backwards. When you advance through the saved station the LED Display Screen will briefly show the selected Pre-Set, then show the Frequency of the Pre-Set in MHz until another Pre-Sets is selected.

NOTE: If the FM radio mode will not appear while scrolling through the **M** options, please turn off the Suitcase Turntable using the Power/Volume Dial and then turn it back on again. The FM Radio mode should now appear in the **M** options.

Using the Headphone Output

The Turntable Briefcase features a 3.5mm headphone output. When headphones or external speakers with a 3.5mm connection are attached to the Turntable Briefcase via the headphone output, all sound will be diverted to the headphones or external speakers, and no sound will be played via the inbuilt speakers. Ensure that the 3.5mm plug is removed from the Turntable Briefcase when required, to ensure that sound is played via the unit's inbuilt speakers once again.

NOTE: There will be no output from the inbuilt speakers while there is any connection present in the headphone output socket.

Using the RCA Audio Output

The Turntable Briefcase features an RCA Audio Output located on the rear of the unit, which allows you to connect the Turntable Briefcase to external speakers. To use the RCA Audio Output, follow the steps below.

1. Turn the **Power/Volume Dial** clockwise until you hear a 'click' sound. The LED Display Screen will show the welcome message HI briefly, then show -PHO indicating that the Turntable mode is active. This is the default setting for the Turntable Briefcase.
2. Plug the AV connections of the RCA cable (not included) into the RCA Audio Output.

NOTE: The red and white coloured AV connections should be connected to the matching red and white AV connection sockets.

3. Insert the other end/s of the RCA cable (not included) into the audio input of the external speakers.

Instructions (cont.)

NOTE: The volume can only be controlled on the connected speakers.

Recording from the Turntable to USB Drive / Micro SD Card

The Turntable Briefcase features a recording function allowing for vinyl records to be recorded to USB drive or Micro SD card. To use the recording function, follow the steps below.

1. Turn the **Power/Volume Dial** clockwise until you hear a 'click' sound. The LED Display Screen will show the welcome message HI briefly, then show -PHO indicating that the Turntable mode is active. This is the default setting for the Turntable Briefcase.
2. Insert either a USB drive or Micro SD card into the LED Control Panel.

NOTE: If there is any music already present on the storage device the Turntable Briefcase will automatically select the relevant playback mode and begin playback automatically. Press the **M** button to scroll back to Turntable mode shown as -PHO on the LED Display Screen.

3. Prepare the Turntable Briefcase and vinyl record for playback by following steps 1 through 7 on page 12 for vinyl record playback. **Do not lower the stylus at this point.**

IMPORTANT: When the recording begins it will create a new track and retain the music already on the USB drive or Micro SD card. Ensure there is adequate storage room for the length of your recording on the USB drive or Micro SD card.

4. With the vinyl record spinning, press and hold the **M** button until you hear a single beep sound. The LED Display Screen will show the rEc message briefly and the recording time will appear.
5. Lower the Stylus to the vinyl record using the Cue Lever. The audio output from the vinyl record will now be captured on either USB drive or Micro SD card.
6. Once you have finished recording, lift the Tone Arm using the Cue Lever to stop the sound production.
7. Press and hold the M button once more until two beeps are heard. The LED Display Screen will show the StOP message briefly and the recording will immediately stop.

Deleting Music from USB Drive / Micro SD Card

You can manage the stored music on the USB drive and Micro SD card directly from the Turntable Briefcase. To clear the stored music from either a USB drive or Micro SD card follow the steps below.

1. Turn the **Power/Volume Dial** clockwise until you hear a 'click' sound. The LED Display Screen will show the welcome message HI briefly, then show -PHO indicating that the Turntable mode is active. This is the default setting for the Turntable Briefcase.
2. Insert either a USB drive or Micro SD card into the LED Control Panel. Playback will begin automatically.
3. Select the track you wish to delete. Wait for playback of the selected track to begin.
4. Once the track is playing press and hold the **▶II** button. The LED Display Screen will show the dEl message briefly. The track that was playing has now been permanently deleted.
5. Repeat the above steps 3 through 4 until you have deleted the required tracks.

Instructions (cont.)

Replacing the Stylus

1. Unlock Tone Arm Lock by moving it up and away from the Tone Arm itself.

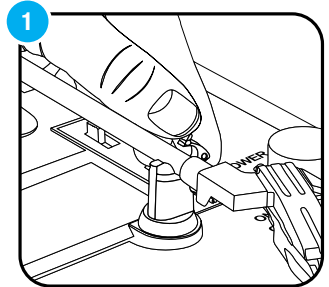

2. Remove the protective cover from the stylus cartridge to expose the needle.

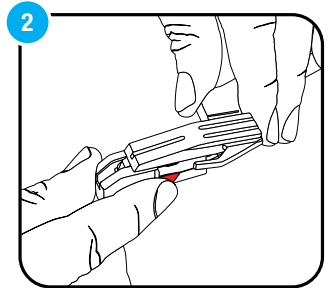

3. Separate the cartridge from the cartridge holder.

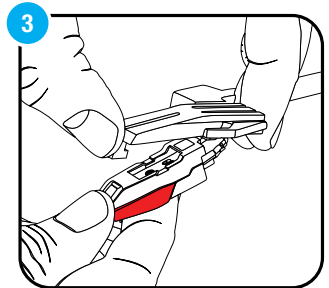

4. Gently pull the audio-lines from the cartridge, taking care to pull from the terminal connector and not the wire itself.

NOTE: Please exercise care whilst performing this operation so as to avoid damaging the Tone Arm and audio-lines.

NOTE: Please ensure the Turntable Briefcase has been turned OFF and unplugged before attempting to replace the stylus.

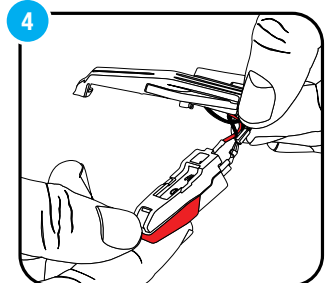

Instructions (cont.)

5. Carefully insert the audio-lines into the new cartridge.

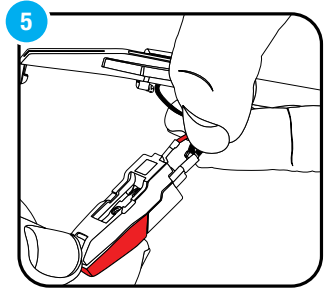

6. Make sure the audio-lines are not touching each other.

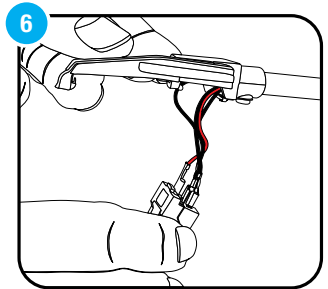

7. Carefully slide the cartridge into the cartridge holder.

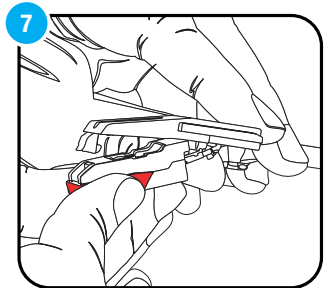

8. Gently clip the cartridge into the cartridge holder.

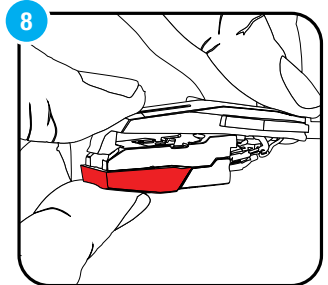

Frequently Asked Questions

Q: Can I carry the Turntable Briefcase by the handle?

A: Yes. But only when the Turntable Briefcase Lid is locked down using the latch. Never carry the Turntable Briefcase without the lid locked down.

Q: Why is the Turntable Briefcase not powering on?

A: Ensure that each end of the Power Adaptor has been correctly and securely connected, and the power socket has been switched on.

Q: Why is there no sound coming from the speakers?

A: Ensure there is no cable connected to the Headphone input or the RCA Audio Output.

A: Check that the volume control is adjusted or that any connected digital devices have their volume adequately set.

Q: Why is the Turntable not spinning?

A: If the Auto Stop Switch is set to the ON position the Turntable Platter will only spin once the Tone Arm has been moved from the Tone Arm rest.

Q: Why is the sound distorted when playing a vinyl record?

A: The Stylus may be damaged. Remove and replace it with a new Stylus (see page 18 for further details).

Q: Why is bt flashing on the LED Display Screen?

A: You have selected Bluetooth® playback and the Turntable Briefcase is attempting to connect to a previously paired device or is waiting for you to pair a new Bluetooth® enabled device.

Q: Why can I not connect via Bluetooth?

A: Check that your device has Bluetooth® switched on and that you are in range of the Turntable Briefcase.



Signify[®]

Retro Turntable Briefcase

Repair and Refurbished Goods or Parts Notice

REGISTER YOUR PURCHASE AT www.aldi.com.au/en/about-aldi/product-registration/
TO KEEP UP-TO-DATE WITH IMPORTANT PRODUCT INFORMATION

Unfortunately, from time to time, faulty products are manufactured which need to be returned to the Supplier for repair.

Please be aware that if your product is capable of retaining user-generated data (such as files stored on a computer hard drive, telephone numbers stored on a mobile telephone, songs stored on a portable media player, games saved on a games console or files stored on a USB memory stick) during the process of repair, some or all of your stored data may be lost.

We recommend you save this data elsewhere prior to sending the product for repair.

You should also be aware that rather than repairing goods, we may replace them with refurbished goods of the same type or use refurbished parts in the repair process.

Please be assured though, refurbished parts or replacements are only used where they meet ALDI's stringent quality specifications.

If at any time you feel your repair is being handled unsatisfactorily, you may escalate your complaint. Please telephone us on 1300 777 137 or write to us at:

UNCLE BILL'S AUSTRALIA PTY LTD
48B Egerton Street, Silverwater NSW 2128 Australia
1300 777 137 Opening Hours - 9:00am - 4:30pm (Mon-Fri), 9:00am - 3:00pm (Sat)
service@unclebills.com.au www.signifyelectronics.com.au

AFTER SALES SUPPORT
 1300 777 137

service@unclebills.com.au
MODEL: EA2147 PRODUCT CODE: 718210 12/2024



Other Useful Information

Cleaning and Maintenance

Before cleaning the Turntable Briefcase, ensure the unit is switched off and disconnected from the power source.

The Turntable Briefcase is likely only to require regular “dusting” to keep it clean. Use a standard duster, or dry soft microfibre cloth to remove the dust from the unit.

If the Turntable Briefcase becomes soiled with anything other than dust on its exterior, clean the exterior of the unit by wiping over the surface with a slightly damp cloth and then polish with a soft dry cloth. Ensure that no moisture or liquid enters the Turntable Briefcase, particularly around the control panel and dials.

Be careful when wiping over the Turntable Briefcase, that you do not apply too much pressure, as there is a risk that you may break parts.

Do not use detergents or abrasive cleaners, and do not allow moisture, water or other liquid to enter the Turntable Briefcase.

Storage

When the Turntable Briefcase is not in use, disconnect it from the power source and store in a cool, dry and well ventilated location out of direct sunlight. Ensure that it is not subject to humidity.

Other Useful Information (cont.)

Responsible Disposal

At the end of its working life, do not throw this appliance out with your household rubbish. Electrical and electronic products contain substances that can have a detrimental effect on the environment and human health if disposed of inappropriately. Observe any local regulations regarding the disposal of electrical consumer goods and dispose of it appropriately for recycling. Contact your local authorities for advice on recycling facilities in your area.

Please keep the original packaging carton and materials in a safe place. It will help to prevent any damage if the product needs to be transported in the future. In the event it is to be disposed of, please recycle all packaging material where possible.

If you require an alternative format of this instruction manual such as website, DVD or by email please contact service@unclebills.com.au to obtain a copy.



The Turntable Briefcase has been fully tested and meets all requirements as set out by the below testing standards:

AS/NZS 62368-1

Trademark



The Bluetooth® word mark and logos are registered trademarks owned by Bluetooth SIG, Inc. and any use of such marks by the manufacturer is under license. Other trademarks and trade names are those of their respective owners.

Specification Table

MODEL:	EA2147
UNIT POWER CONSUMPTION:	5W
AC ADAPTOR MODEL:	GQ07-050100-AA
ADAPTOR INPUT VOLTAGE:	100-240V~ 50/60Hz 0.3A MAX CLASS II
ADAPTOR OUTPUT VOLTAGE:	5V  1A
USB:	5V  150mA
SPEAKERS:	2 x 5W STEREO SPEAKERS
RPM:	SUPPORTS PLAYBACK SPEEDS 33.33, 45, 78 RPM
RECORD SIZE SUPPORTED:	7" = 17.7cm 10" = 25.5cm SP 12" = 30cm LP
DIMENSIONS:	35 x 27 x 12cm
WEIGHT:	2.5kg
VERSION NO:	2
ISSUE DATE:	5 th August, 2024

THIS DOCUMENT CONTAINS INFORMATION THAT IS SUBJECT TO CHANGE WITHOUT NOTICE.

AFTER SALES SUPPORT

  1300 777 137

 service@unclebills.com.au

MODEL: EA2147 PRODUCT CODE: 718210 12/2024



ALDI guarantees that our exclusive brand products are developed to our stringent quality specifications. If you are not entirely satisfied with this product, please return it to your nearest ALDI store within 60 days from the date of purchase for a full refund or replacement, or take advantage of our after sales support by calling the supplier's Customer Service Hotline.



Made in China

ALDI STORES, 1 SARGENTS ROAD

MINCHINBURY NSW 2770

www.aldi.com.au

AFTER SALES SUPPORT



AU 1300 777 137



service@unclebills.com.au

MODEL: EA2147

PRODUCT CODE: 718210

12/2024

1

YEAR WARRANTY